

**Electrical Information:**

Breaker Panel: 1  
Service Type: 120/208  
Panel Type: A Series II  
Panel Number: B85324002  
Manufacturer: General Electric  
Amps: 400  
Location: Electrical Room

Breaker Panel: 2  
Service Type: 120/208  
Panel Type: NQOD  
Panel Number: Not Listed  
Manufacturer: Square D  
Amps: 150  
Location: Electrical Room  
Note: No UL Label

Breaker Panel: 3  
Service Type: 277/480  
Panel Type: NF  
Panel Number: Not Listed  
Manufacturer: Square D  
Amps: 400  
Location: Electrical Room  
Note: UL Label

**Exterior Disconnect Information:**

Amps: 200  
Panel Type: Heavy Duty Safety Switch  
Panel Number: Not Listed  
Manufacturer: Square D  
Location: Rear of Unit  
Note: No UL Label

**Ceiling Information:**

Height from Floor to Ceiling:  
Front: 8' 3" Back: 9' 11"  
Floor to Bottom of Deck:  
Front: 20' 10" Back: 18' 8"  
Floor to Bottom of Joist:  
Front: 19' 4" Back: 17'

**Fire Information:**

Riser Location: No Riser in Unit  
Sprinkler Heads Present: Yes  
Number of Sprinkler Heads: 38  
Fire Alarm Control Panel Present: Yes  
Brand: Unimode  
Model: 9050UD  
Location: Electrical Room

**Water Heater Information:**

Gallons: 40  
Water Line (in): 1/2"  
Manufacturer: AO Smith  
Model: ECS 40 200  
Serial: J06A021121  
Location: Electrical Room

**Backflow Information:**

Number: 0  
Size: N/A  
Location: No Backflow Preventer Present

**HVAC Information:**

Unit: 1  
Manufacturer: RHEEM  
Model: RLKB-A120DM000  
Serial: 6348F050306306  
Tonnage: 10  
Year: 2003

Unit: 2  
Manufacturer: RHEEM  
Model: RLKB-A120DM000  
Serial: 6348F010309955  
Tonnage: 10  
Year: 2003

Unit: 3  
Manufacturer: RHEEM  
Model: RLKB-A120DM000  
Serial: 6348F120312335  
Tonnage: 10  
Year: 2003

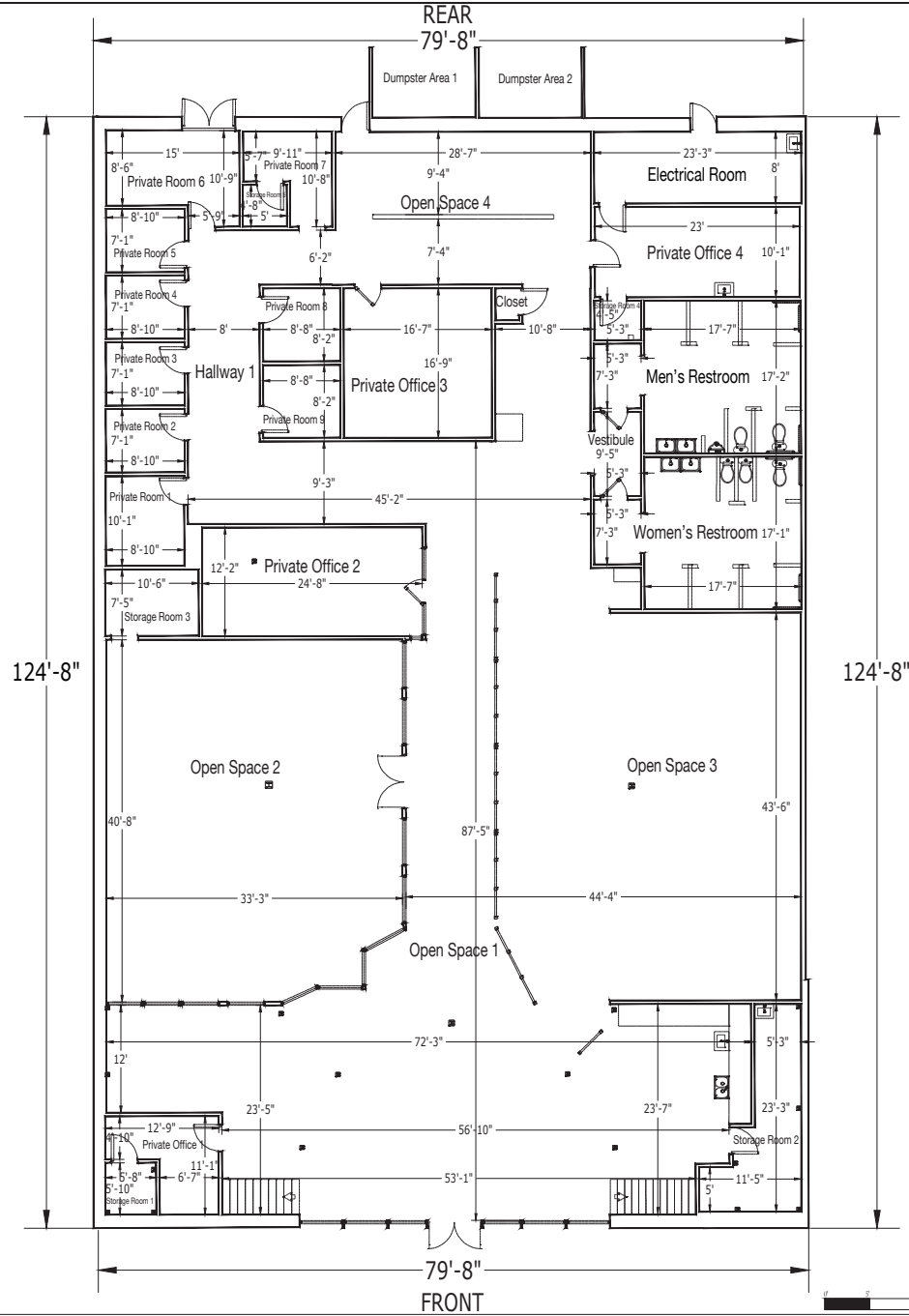

1 MAIN FLOOR

**Village at Lee Branch**

Unit # 300  
220 Doug Baker Blvd.  
Suite 100  
Birmingham, AL 35242



Black Creek Group  
518 17th Street  
Suite 130  
Denver, CO 80202

**Unit # 300  
9,932 SF**

Square footage shown includes measured on-site and adheres to BOMA standards

Width  
79'-8"

Depth  
124'-8"

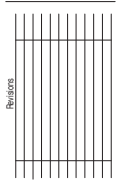

Site Map  
Prepared 2/28/2020  
Unit # 300

Plans produced by:  
ID Plans

400 N. Tampa St. Suite 2110  
Tampa, FL 33602  
Phone: 888-657-2545  
IDPlans.com



Site map is for general use and purposes only. ID Plans does not guarantee the accuracy or validity of printed information. Measurements are not intended to be architecturally used for construction purposes or accepted as a replacement for documents, drawings, or make any intended or claimed to be structurally accurate, such as site locations. The party user shall retain the right and responsibility to verify, check, or alter the provided information as well time for any reason.

Virtual Tour Link

**Village at Lee Branch**

Unit # 300  
 220 Doug Baker Blvd.  
 Suite 100  
 Birmingham, AL 35242



Black Creek Group  
 518 17th Street  
 Suite 1700  
 Denver, CO 80202

**Unit # 300  
 Mezzanine Level  
 1,040 SF**

Small square footage shown was measured on-site and adheres to BOMA standards

Width  
 79'-8"

Depth  
 25'

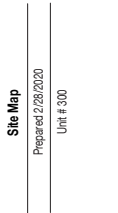
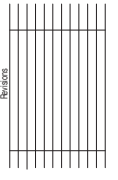

Plans produced by:  
**ID Plans**

400 N. Tampa St. Suite 2210  
 Tampa, FL 33602  
 Phone: 866-657-2545  
 IDPlans.com



Site map is for general use and purposes only. ID Plans does not guarantee the accuracy or validity of printed information. Measurements are not intended to be architecturally used for construction purposes or accepted as requirements for documents, drawings, or make intending or claiming to be structurally accurate, such as site locations. The property owner shall retain the right and responsibility to verify, change, or alter the provided information as well time for any reason.

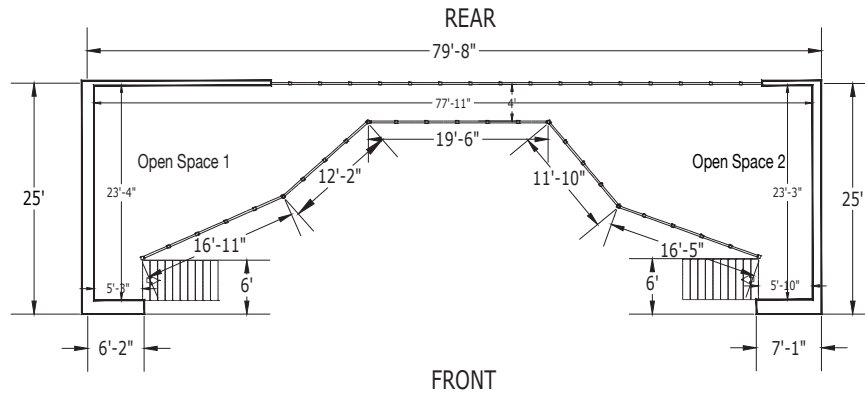

**M** MEZZANINE LEVEL





**Space Profile for**

Unit: # 300

Area: 10,972 sq ft

**Address**

220 Doug Baker Blvd.  
Suite 100  
Birmingham, AL 35242



400 N. Tampa St. Suite 2210  
Tampa, FL 33602

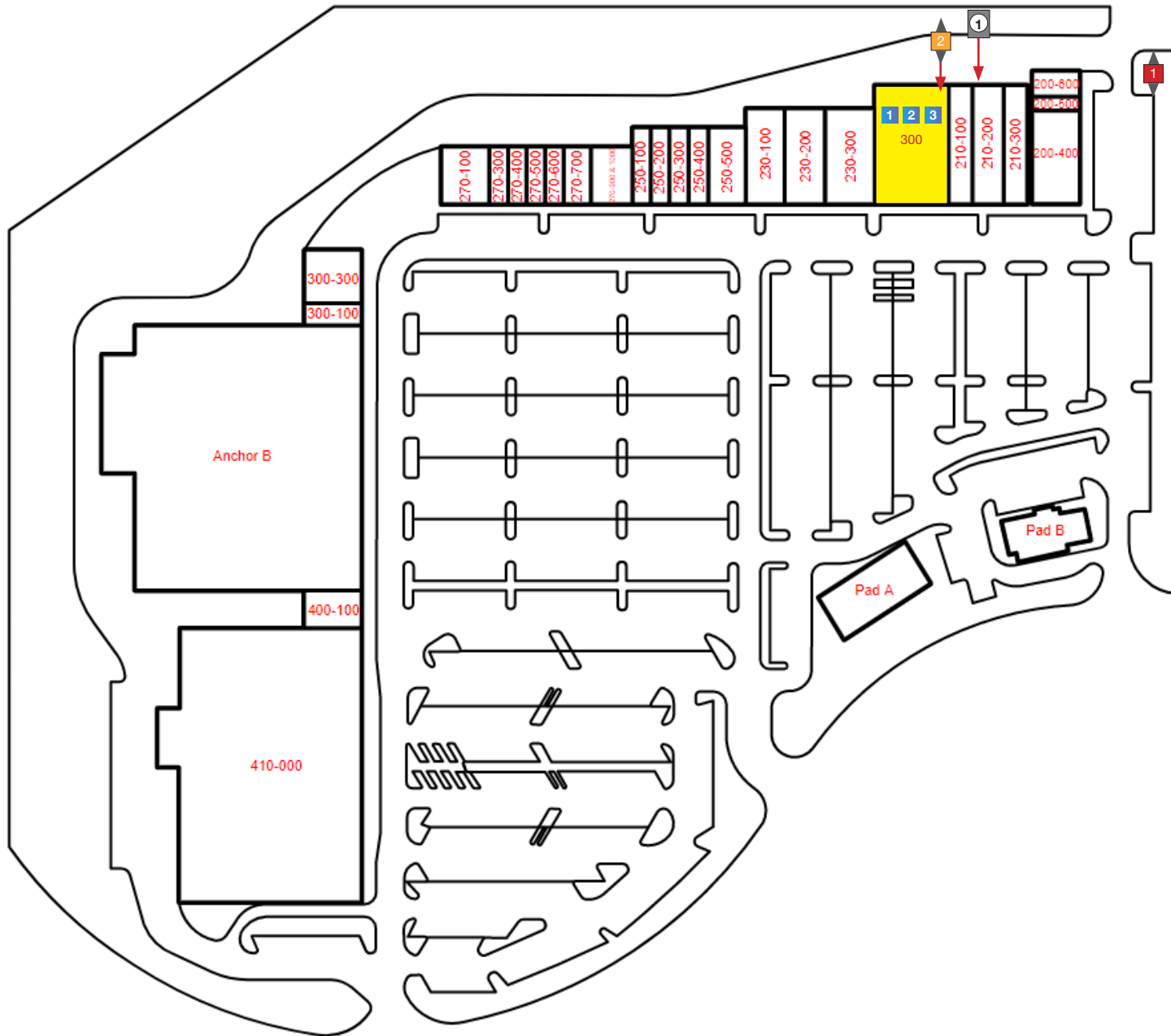





**Prepared**  
02/28/2019

**Address**  
220 Doug Baker Blvd.  
Suite 100  
Birmingham, AL 35242

**Please See Meter & HVAC Information on the Next Page**















































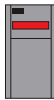

**Meter & HVAC Information**

Meter Information	Reference	Meter
	 Electric	3031127
	 Gas	None
	 Water (House)	18000390*
	 Water (Sub)	No Number

\*Note: Vault Locked

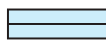
HVAC Units & Information	Unit	Space	Manufacturer	Model	Ton	Serial	Year
	1	300	RHEEM	RLKB-A120DM000	10	6348F050306306	2003
	2	300	RHEEM	RLKB-A120DM000	10	6348F010309955	2003
	3	300	RHEEM	RLKB-A120DM000	10	6348F120312335	2003

# Legend

	Breaker Panel		Fire Extinguisher		Ceiling Fan w/ Light		Fire Sprinkler
	Circular Column		Fire Alarm Pulldown		Rectangular Column		Pocket Door
	Appliance Outlet		Glass Door		Refrigerator		Track Lighting
	Fire Alarm		Handicap Handrail		Roll-Up Door		2-Bulb Fluorescent Lighting
	Drinking Fountain		Roof Hatch		Sink		3-Bulb Fluorescent Lighting
	Door		HVAC Unit		Swing Door		4-Bulb Fluorescent Lighting
	Double Hung Door		Recessed Light		Toilet		Ceiling Air Vent
	Electrical Outlet		Staircase		Can Light		Air Diffuser
	Emergency Light		Water Heater		Urinal		Ceiling Fan w/o Light
	Exit Light		Telephone Panel		Thermostat		Air Handler
	Tankless Water Heater		Window Wall Opening		RJ 45		Fire Alarm Control Panel
	Step Down Transformer		Maintenance Sink		Window		Grease Trap
	Disconnect						Grease Trap

Disclaimer: All items may not show on feature pages.

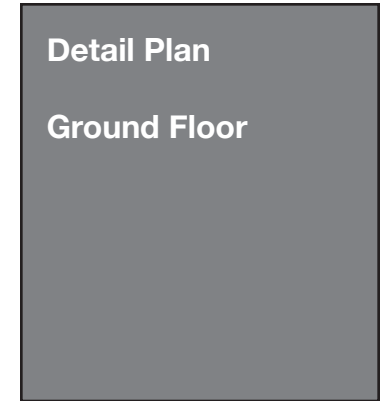
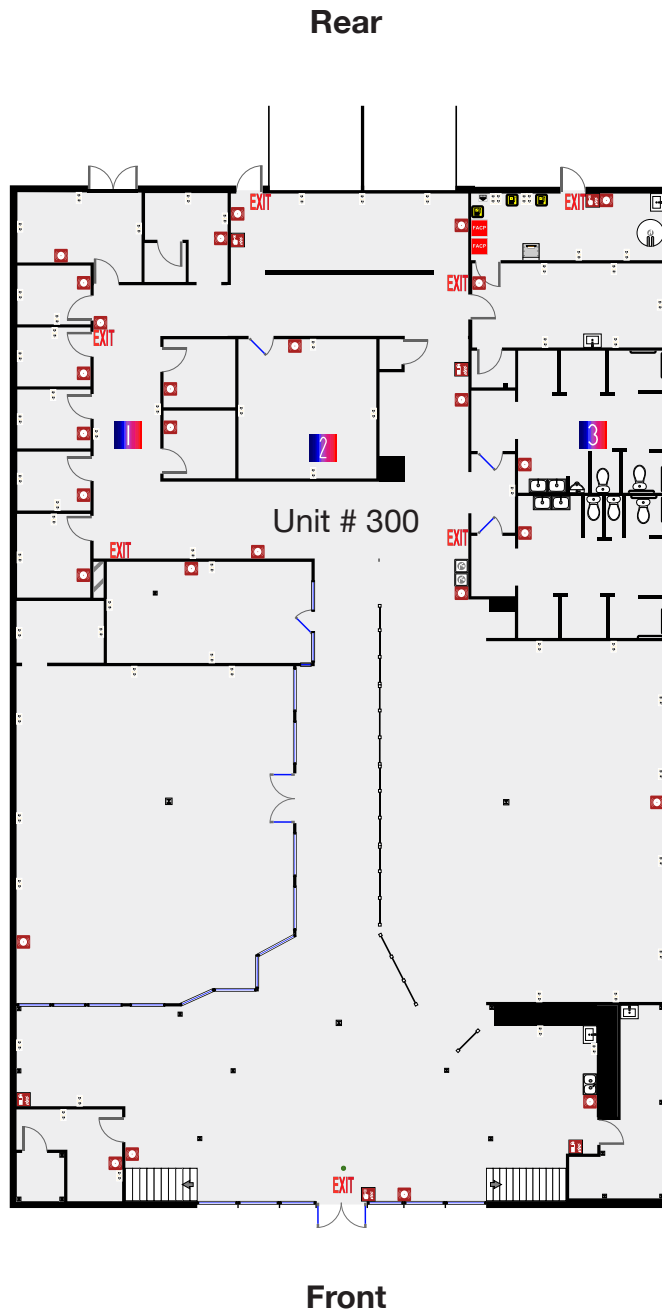

Detail Plan  
Mezzanine Level

